

Denali SoundBomb

Split Dual-Tone Air Horn

TT-SB.10100.B Instructions Rev:00

PLEASE READ BEFORE INSTALLING

TWISTED THROTTLE products should be installed by a qualified, experienced motorcycle technician. If you are unsure of your ability to properly install a product, please have the product installed by your local motorcycle dealer. TWISTED THROTTLE takes no responsibility for damages caused by improper installation.

All screws, bolts, and nuts, including all replacement hardware provided by TWISTED THROTTLE should be tightened to the torque specified in the OEM maintenance manual for your motorcycle. If no torque specifications are provided in the OEM maintenance manual, the following torques may be used:

M5.....	3.5 ft-lbs (5 Nm)
M6.....	7 ft-lbs (9.6 Nm)
M8.....	13 ft-lbs (18 Nm)







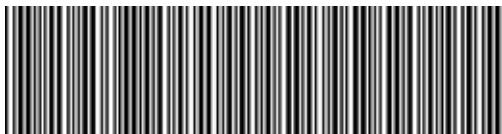

All screws, bolts, and nuts should be checked after driving the first 30 miles (50 km) to ensure that all are tightened to the proper torque.

Medium strength liquid thread-locker (i.e., "Locktite") should be used to secure all screws, bolts, and nuts.

Distributed by:	
Twisted Throttle LLC 570 Nooseneck Hill Rd Exeter, RI 02822	phone: 401.284.4200 fax: 401.223.6955 www.twistedthrottle.com



Kit Contents

1 Compressor  LAH.08.005 Qty.....1	2 Acoustic Unit  LAH.08.004 Qty.....1	3 Hose  Length: 42" Qty.....1	4 Hex Head Screw  M8x16.....DIN 933 Qty.....1	5 Nylock Nut  M8.....DIN 985 Qty.....1	6 Hex Head Screw  M6x20.....DIN 933 Qty.....1	7 Vibration Dampener  M6 Qty.....1	8 Nylock Nut  M6.....DIN 985 Qty.....1	9 Zip Tie  M8 Qty.....2
----------------------------------------------------------------------------------------------------------------------------------------	-------------------------------------------------------------------------------------------------------------------------------------------	-----------------------------------------------------------------------------------------------------------------------------------	---------------------------------------------------------------------------------------------------------------------------------------------------	----------------------------------------------------------------------------------------------------------------------------------------------	-----------------------------------------------------------------------------------------------------------------------------------------------------	------------------------------------------------------------------------------------------------------------------------------------------	----------------------------------------------------------------------------------------------------------------------------------------------	-------------------------------------------------------------------------------------------------------------------------------

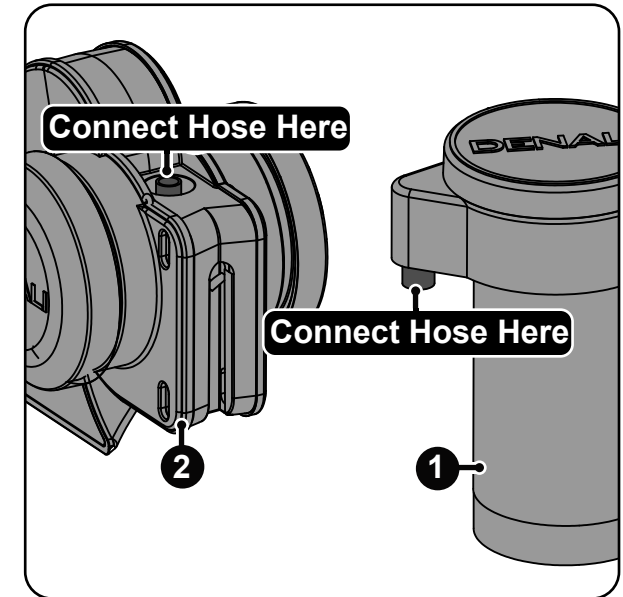
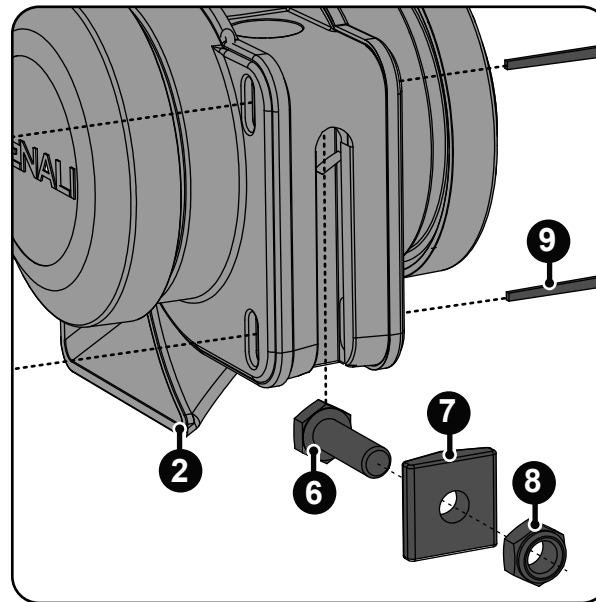
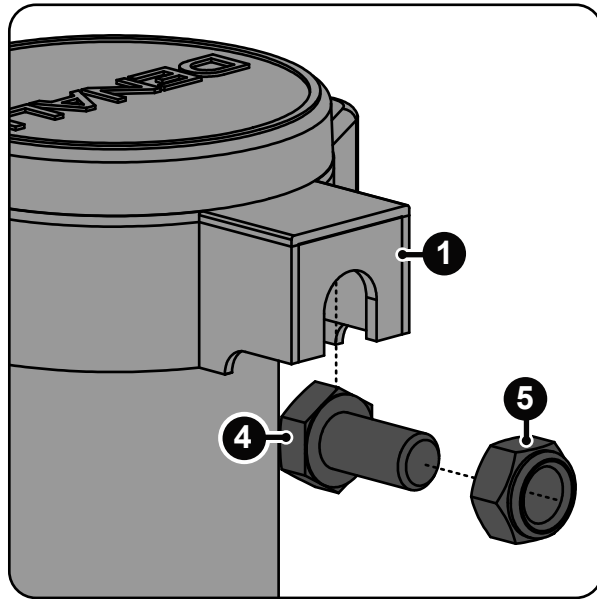

Compressor Mounting: Use the M8 bolt (#4) and nut (#5) to secure the compressor to you motorcycle.

Acoustic Unit Mounting:

- Option One:** Use the M6 bolt (#6), vibration dampener (#7), and nut (#8) to secure the acoustic unit to the motorcycle.
- Option Two:** Slide the zip ties (#9) through the slots illustrated above, then secure the acoustic unit to the motorcycle.

Hose Routing: Route the hose (#3) through the motorcycle to connect the two units. Be sure to avoid areas of extreme heat such as the engine head or exhaust. Once the hose has been routed between the two units, trim the hose to the correct length. Next you can push each end of the hose onto the nipples on the compressor and acoustic unit. It is helpful to heat up the ends of the hose using a heat gun before pushing them onto each unit.

Note: This drawing is not to scale. Components are enlarged for illustrative purposes only.

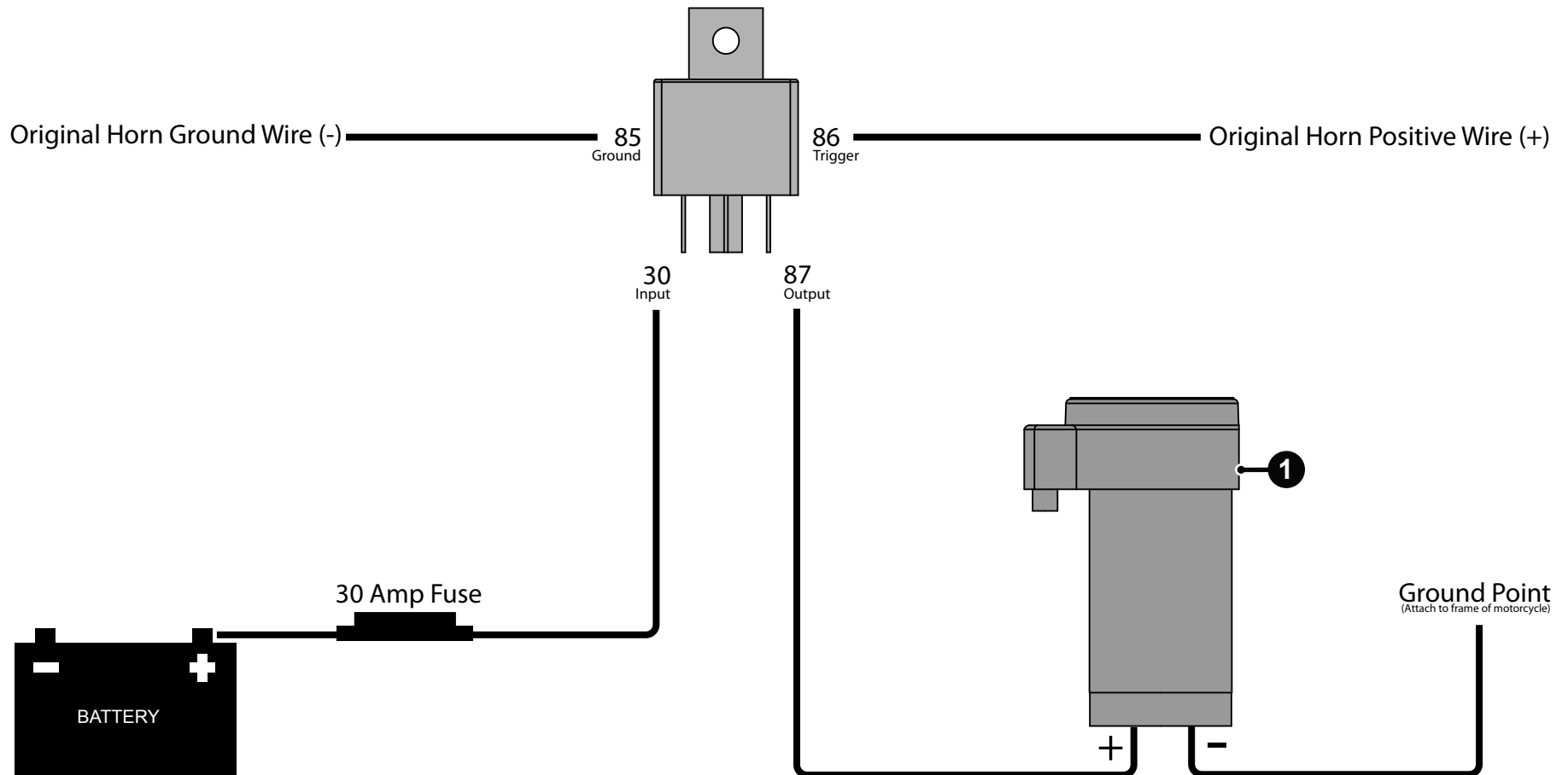

How to Wire:

1. Connect terminal 85 to the original horn ground wire (-)
2. Connect terminal 30 to the battery positive terminal (+). Do not install the fuse at this time.
3. Connect terminal 87 to the positive terminal (+) located on the bottom of the SoundBomb compressor.
4. Connect a ground wire from the negative terminal (-) located on the bottom of the SoundBomb compressor, to a ground point on the motorcycle.
5. Connect terminal 86 to the original horn positive wire (+)
6. Install a 30 amp fuse in the fuse holder